



EXPLOSIVE, GUN & IMPACT TESTING

 **PCB PIEZOTRONICS**
AN AMPHENOL COMPANY

 **TEST SYSTEMS**
drgania • akustyka • termowizja • szybkie kamery

EXPLOSIVE, GUN & IMPACT TESTING

SENSORS FOR BLAST MEASUREMENTS

Shock Accelerometers: Our high amplitude shock accelerometers represent state-of-the-art industry technology for miniature, high amplitude, DC response acceleration sensors, capable of measuring long duration transient motion, as well as responding to and surviving extremely fast rise times typical of a high-G shock event. Both a packaged and an OEM configuration are offered to fulfill a variety of installation requirements.

Pressure Sensors: Our pressure sensors are designed for a broad range of explosion, blast, and shock wave testing. They are frequency tailored to capture both peak pressure and total impulse measurements. Applications include measuring air-blast pressure in free-field or closed bunker arenas to obtain peak pressure, total impulse, shock wave and time-of-arrival measurements often used to study blast effects on structures, vehicles, or other objects.

In this catalog, you will find a listing of PCB®'s most popular blast, high-G shock sensors and other hardware for these applications. Please log onto www.pcb.com, and search the model series for detailed specifications. You can also contact us at 866-816-8892, or sales@pcb.com, to discuss your specific requirement with an Application Engineer.

CIVILIAN APPLICATIONS INCLUDE:

- Mining
- Construction
- Demolition
- Pyrotechnics

DEFENSE APPLICATIONS INCLUDE:

- Aerial Bombs
- Mines
- Torpedoes
- Breaching Operations
- Ballistics
- Tactical Missiles & More

TABLE OF CONTENTS

MEMS High-G Shock Accelerometers	4 - 5
Piezoelectric Accelerometers	6 - 9
Low Cost, Embeddable Accelerometers Series 660	6 - 8
High Amplitude ICP® Shock Accelerometers Series 350	9
Pressure Products for Blast Testing	10 - 17
High Frequency Series 113B	11 - 12
Ground Isolated Series 102B	13
ICP® High Intensity, Acoustic Sensors Series 106B	14
Time of Arrival ICP Micro-pressure Sensors Series 132	15
Tourmaline Pressure Bar Series 134	15
Free Field Blast Pressure Pencil Probe Series 137	16
Tourmaline Underwater Blast Series 138	17
Pressure Products for Ballistic Testing	18 - 22
ICP® Ballistic Sensors Series 109	19
Conformal Ballistic Sensors Series 117B	20
Shot Shell Sensor Series 118A07	22
Force & Strain Products for Structural Impact	23 - 24
Impact Force Sensors 201B and 208C	23
Dynamic Force Strain 740B02	24
Placebo Transducers	26 - 27
Calibration Products	28 - 31
Calibration Systems	28
Special Purpose	29
Shock Accelerometer Calibration Model 9525C	31
Specialized Instrumentation	32 - 33
Firearms Detection Systems Model LXT1-QPR	32
Ballistic Peak Pressure Monitoring System Model 444A53	33
Signal Conditioning and Converters	34 - 36



MEMS PIEZORESISTIVE SHOCK ACCELEROMETERS

Piezoresistive shock accelerometers, manufactured by MEMS technology, have low power consumption while still providing +/- 200 mV full scale output at acceleration levels greater than 50 g. The accelerometers are electrically compatible with the same type 4-wire circuit used to condition a strain gauge full bridge and since they have much greater output compared to a strain gauge, the requirement for signal amplification is greatly reduced. They afford a wider operating temperature range when compared to mechanically isolated ICP® accelerometers. Their frequency response, dependent on model, can be uniform from DC (0 Hz) to values as high as 20 kHz. To lessen the severity of response when their resonant frequency is excited, they incorporate squeeze film damping, achieving values of 0.02 to 0.06 of critical. These damping values are much higher than those found in legacy MEMS accelerometers. Since silicon is a brittle material, over range stops are also incorporated to minimize breakage of the sensing element, and then the sensing element is sealed within a hermetic package. At comparable G levels, MEMS technology enables the smallest package size to be attained for individual accelerometers.

HIGHLIGHTS:

- Single axis and triaxial arrangements
- Mechanical over-range stops improves survivability
- Slight damping reduces resonance amplification
- Excellent amplitude linearity
- Low power consumption

APPLICATIONS:

- Metal-to-metal impact & pyroshock
- Data recorders, penetrator & launch tests
- Consumer electronics drop testing
- Sporting goods and impact tool testing
- Blast loading & survivability of structures
- Fuze, safe and arm



2000 G MEMS SHOCK ACCELEROMETER

- Sensitivity: 0.02 mV/V/g (0.002 mV/V/(m/s²))
- Measurement Range: ±2000 g pk (±19613 m/s² pk)
- Frequency Range (±1dB): 0 - 10000 Hz

20000 G MEMS SHOCK ACCELEROMETER

- Sensitivity: 0.001 mV/V/g (0.0001 mV/V/(m/s²))
- Measurement Range: ±20000 g pk (±196100 m/s² pk)
- Frequency Range (±1dB): 0 - 10000 Hz

60000 G MEMS SHOCK ACCELEROMETER

- Sensitivity: 0.0003 mV/V/g (0.00003 mV/V/(m/s²))
- Measurement Range: ±60000 g pk (±588400 m/s² pk)
- Frequency Range (±1dB): 0 - 20000 Hz



STUD MOUNT SINGLE AXIS

MODEL 3501B122KG
MODEL 3501B1220KG
MODEL 3501B1260KG



SURFACE MOUNT SINGLE AXIS

MODEL 3501A202KG
MODEL 3501A2020KG
MODEL 3501A2060KG



SURFACE MOUNT TRIAXIAL

MODEL 3503C202KG
MODEL 3503C2020KG
MODEL 3503C2060KG



THRU HOLE MOUNT SINGLE AXIS

MODEL 3991B112KG
MODEL 3991B1120KG
MODEL 3991B1160KG



THRU HOLE MOUNT TRIAXIAL

MODEL 3503A112KG
MODEL 3503A1120KG
MODEL 3503A1160KG



TRIAXIAL MOUNTING BLOCK

MODEL 080A213

- For Model 3991B11XXKG



LN MINI 8-PIN DIN CONNECTOR

- Bridge input mating connector



LY MINI 8-PIN DIN CONNECTOR

- Bridge input mating connector

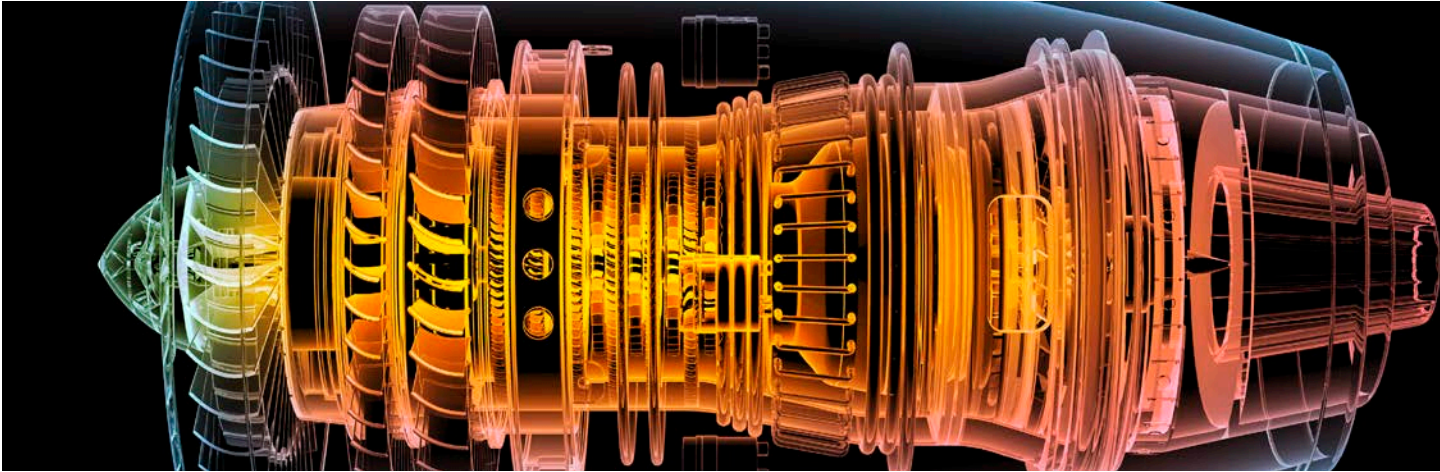

PIEZOELECTRIC ACCELEROMETERS

SERIES 660 (TO-5 PACKAGE) LOW COST, EMBEDDABLE ACCELEROMETERS

Series 660 accelerometers are ideal for continuous vibration monitoring in high-volume and commercial OEM applications.

The Series 660 low cost accelerometers offer an affordable solution for vibration and shock measurements in high-volume and commercial OEM applications. The units are particularly well suited for shock and impact detection of packages or components, as well as bearing and gear mesh vibration measurements in predictive maintenance and condition monitoring requirements. The compact designs may be imbedded into machinery at the OEM level to provide value-added monitoring protection.

The units employ field-proven, solid-state, piezoelectric sensing elements for durability and broadband performance. Choose from either charge mode types, which achieve high operating temperatures or voltage mode ICP® types, with built-in signal conditioning microelectronics, for simplified operation and connectivity to data acquisition and vibration monitoring instrumentation.

HIGHLIGHTS:

- Choice of standard TO-5 or TO-8 transistor-style packages
- Choice of charge mode piezoelectric, voltage mode ICP®, and 3-wire low power varieties
- Mountable via adhesive or soldering and choice of either integral cable or solder pin electrical connections
- Variety of sensitivities to accommodate a wide variety of applications
- Broad bandwidth, high shock survivability, wide operating temperature range, high resolution, and large dynamic range

OPTIONS:

- Low Output Bias Voltage
- High Temperature Operation to 365 °F (185 °C)
- High Range (less sensitivity)
- Temperature Output Signal

SPECIFICATIONS

Package Size	Low Profile TO-5	TO-5
2-Wire ICP Configuration		
Primary Model Sensitivity ($\pm 20\%$)	10 mV/g 1.02 mV/m/s ²	100 mV/g 10.2 mV/m/s ²
Measurement Range	500 g 5000 m/s ²	50 g 500 m/s ²
Frequency Range (± 3 dB)	0.4 to 10 k Hz	0.32 to 10k Hz
Resonant Frequency	>30 kHz	>25 kHz
Broadband Resolution	0.003 g pk	0.0003 g pk
Excitation Voltage	18 to 28 VDC	18 to 28 VDC
Excitation Constant Current	2 to 20 mA	2 to 20 mA
Output Impedance	<100 ohm	<100 ohm
Output Bias Voltage	8 to 12 VDC	8 to 12 VDC
Discharge Time Constant	≥ 0.4 sec	≥ 0.5 sec
Settling Time	2 sec	2.5 sec
Operating Temperature Range	-65 to +185 °F -54 to +85 °C	-65 to +185 °F -54 to +85 °C
Weight	0.08 oz 2.2 gm	0.1 oz 3 gm
Other Available Sensitivities	1 mV/g 0.102 mV/m/s ²	N/A
3-Wire, Low-Power Configuration		
Primary Model Sensitivity ($\pm 20\%$)	10 mV/g 1.02 mV/m/s ²	100 mV/g 10.2 mV/m/s ²
Measurement Range *	200 g 2000 m/s ²	20 g 200 m/s ²
Frequency Range (± 3 dB)	0.32 to 10k Hz	0.32 to 10k Hz
Resonant Frequency	>30 kHz	>25 kHz
Broadband Resolution	0.003 g pk 0.03 m/s ² pk	0.001 g pk 0.01 m/s ² pk
Excitation Voltage	3 to 5 VDC	3 to 5 VDC
Current Draw	0.75 mA	0.75 mA
Output Impedance	< 100 ohm	< 100 ohm
Output Bias Voltage ($\pm 10\%$)	$0.5 \times$ Excitation Voltage	$0.5 \times$ Excitation Voltage
Discharge Time Constant	≥ 0.5 sec	≥ 0.5 sec
Settling Time	2.5 sec	2.5 sec
Operating Temperature Range	-65 to +185 °F -54 to +85 °C	-65 to +185 °F -54 to +85 °C
Weight	0.08 oz 2.2 gm	0.1 oz 3 gm
Charge Mode Configuration		
Sensitivity ($\pm 20\%$)	5 pC/g 0.51 pC/m/s ²	11 pC/g 1.12 pC/ms ²
Measurement Range	500 g	50 g
Frequency Range (± 3 dB)	10 kHz	10 kHz
Resonant Frequency	>30 kHz	>25 kHz
Operating Temperature Range	-65 to +185 °F -54 to +85 °C	-65 to +185 °F -54 to +85 °C
Capacitance	350 pF	350 pF
Weight	0.08 oz 2.2 gm	0.1 oz 3 gm
Common Specifications		
Transverse Sensitivity	$\leq 5\%$	$\leq 5\%$
Non-Linearity	$\leq 1\%$	$\leq 1\%$
Temperature Coefficient	0.10 %/°F 0.18 %/°C	0.10 %/°F 0.18 %/°C
Shock Limit	7000 g pk 70k m/s ² pk	7000 g pk 70k m/s ² pk
Housing Material	Stainless Steel	Stainless Steel
Mounting	Adhesive or Solder	Adhesive or Solder
Sealing (welded)	Hermetic	Hermetic
Size	0.36 × 0.26 in 9.1 × 6.6 mm	0.36 × 0.38 in 9.1 × 9.7 mm

Note:

* Measurement range achieved is dependent upon excitation voltage supplied, i.e.: Measurement Range =

LOW PROFILE TO-5

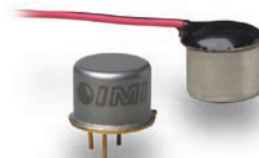

TO-5



2-WIRE ICP® MODE

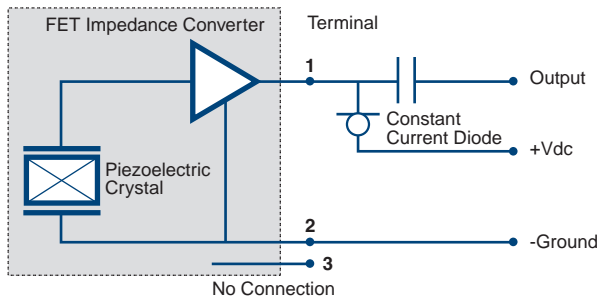

2-WIRE CHARGE MODE

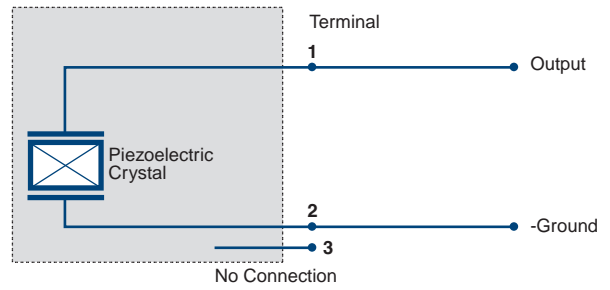

3-WIRE VOLTAGE MODE

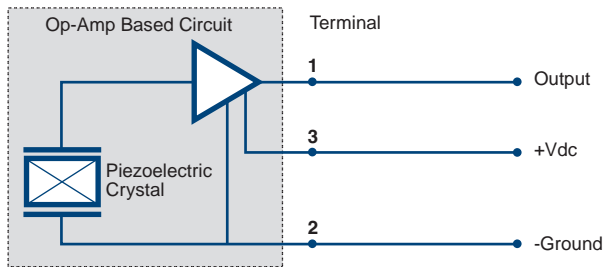

4-WIRE VOLTAGE MODE WITH TEMPERATURE OUTPUT

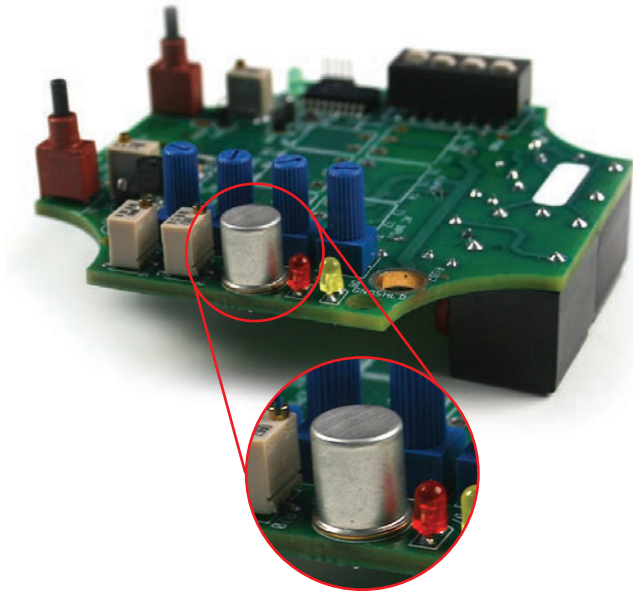
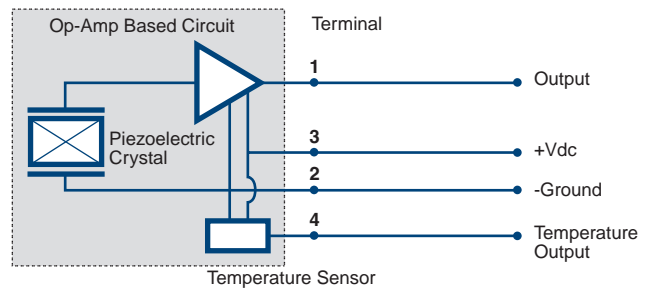

Example of a TO-5 accelerometer mounted on a circuit board

HIGH AMPLITUDE ICP® SHOCK ACCELEROMETERS

Piezoelectric ICP® accelerometers afford a very high signal output (+/- 5 volts full scale) and the ease of two-wire electrical connectivity. Their inherent ruggedness enables them to be severely over ranged without damage. The addition of internal mechanical isolation minimizes the high frequency stress that would otherwise be encountered by their ceramic sensing elements. This mechanical isolation, coupled with an internal 2-pole electrical filter, built into the ICP® circuitry, tailors the overall accelerometer response to assure data quality to frequencies as high as 10 kHz. Depending on the specific model, accelerations in excess of 50 kg can be successfully measured. These modern designs, with their internal elastomeric isolation materials are verified through calibration to remain dynamically linear and are enabling piezoelectric accelerometers to operate in increasingly severe acceleration environments.



SHOCK ICP® ACCELEROMETER

MODEL 350C23

- Sensitivity: 0.5 mV/g (0.05 mV/(m/s²))
- Measurement Range: ±10000 g pk (±98000 m/s² pk)
- Frequency Range (±1 dB): 0.4 - 10000 Hz



SHOCK ICP® ACCELEROMETER

MODEL 350C24

- Sensitivity: 1 mV/g (0.1 mV/(m/s²))
- Measurement Range: ±5000 g pk (±49000 m/s² pk)
- Frequency Range (±1dB): 0.4 - 10000 Hz



SHOCK ICP® ACCELEROMETER

MODEL 350D02

- Sensitivity: 0.1 mV/g (0.01 mV/(m/s²))
- Measurement Range: ±50000 g pk (±490000 m/s² pk)
- Frequency Range (±1dB): 4 - 10000 Hz



SHOCK ICP® ACCELEROMETER

MODEL 350B01

- Sensitivity: 0.05 mV/g (0.005 mV/(m/s²))
- Measurement Range: ±100000 g pk (±981000 m/s² pk)
- Frequency Range (±1 dB): 4 - 10000 Hz



TRIAXIAL SHOCK ICP® ACCELEROMETER

MODEL 350B43

- Sensitivity: 0.5 mV/g (0.05 mV/(m/s²))
- Measurement Range: ±10000 g pk (±98000 m/s² pk)
- Frequency Range (±1dB): 0.4 - 10000 Hz



TRIAXIAL SHOCK ICP® ACCELEROMETER

MODEL 350B44

- Sensitivity: 1 mV/g (0.1 mV/(m/s²))
- Measurement Range: ±5000 g pk (±49000 m/s² pk)
- Frequency Range (±1dB): 0.4 - 10000 Hz



PRESSURE PRODUCTS FOR BLAST TESTING

MEASURING EXPLOSIONS AND PROPELLANT BURNS

Pressure sensors with quartz, ceramic and tourmaline sensing elements are used for a wide variety of shock wave, blast and explosive testing. Typical applications include measurement of shock and blast waves, combustion or detonation in closed bombs, projectile velocity, free field or underwater explosive testing, and squib lot acceptance testing. All of these applications require high frequency response and durability, ability to drive long cables, and operate in adverse environments.

In applications involving long input cables to data acquisition systems, care must be exercised to assure the measurement system has adequate frequency response. Capacitance associated with the long cables can act as a low pass filter. Sensor output voltage, cable capacitance and constant current are factors to be considered. More current is required to drive higher voltages over longer cables. PCB® signal conditioners can be easily field-adjusted up to 20 mA to drive long cables. Selecting a sensor to provide about 1 V full scale for the expected pressure to be measured, rather than 5V, will provide 5 times greater frequency response for a given current and cable length.

Most of the sensors listed in this section incorporate acceleration-compensating sensing elements with integral electronics, which provide a frequency-tailored, non-resonant response. Frequency tailored sensors have microsecond rise time and suppressed resonance to faithfully follow shock wave events without the characteristic “ringing” common in other sensors.

APPLICATIONS:

- Air Blast Measurement
- Underwater Explosion Measurement
- Peak and Total Impulse
- Explosive Research and Structural Loading
- Shock Tube or Closed Bomb Testing
- Wave Velocity and/or Time of Arrival Determinations
- Explosive Component (e.g., Squib) Lot Acceptance



SERIES 113B - HIGH FREQUENCY, GENERAL PURPOSE PRESSURE SENSORS

PCB® Series 113B dynamic pressure sensors set the standard for extremely fast, micro-second response and a wide amplitude and frequency range that allows them to excel in high-frequency applications where minimum sensor diameter is required. Typical applications include combustion studies, explosive component testing (e.g. detonators, explosive bolts), airbag testing, and measurement of air blast shock waves resulting from explosions.

HIGHLIGHTS:

- Fast rise time $\leq 1 \mu\text{sec}$ from quartz element
- Ultra-high resonant frequency of $\geq 500 \text{ kHz}$
- Frequency-tailored output without the “ringing” characteristic of most other sensors
- Internal acceleration compensation minimizes shock and vibration sensitivity



CE



HIGH FREQUENCY ICP® PRESSURE SENSOR

MODEL 113B28

- Sensitivity: 100 mV/psi (14.5 mV/kPa)
- Measurement Range (± 5 Volt Output): 50 psi (345 kPa)
- Low Frequency Response: 0.5 Hz



CE



HIGH FREQUENCY ICP® PRESSURE SENSOR

MODEL 113B27

- Sensitivity: 50 mV/psi (7.25 mV/kPa)
- Measurement Range (± 5 Volt Output): 100 psi (690 kPa)
- Low Frequency Response: 0.5 Hz



CE



HIGH FREQUENCY ICP® PRESSURE SENSOR

MODEL 113B21

- Sensitivity: 25 mV/psi (3.6 mV/kPa)
- Measurement Range (± 5 Volt Output): 200 psi (1380 kPa)
- Low Frequency Response: 0.5 Hz



CE



HIGH FREQUENCY ICP® PRESSURE SENSOR

MODEL 113B26

- Sensitivity: 10 mV/psi
(1.45 mV/kPa)
- Measurement Range (± 5 Volt Output):
500 psi (3450 kPa)
- Low Frequency Response: 0.01 Hz



CE



HIGH FREQUENCY ICP® PRESSURE SENSOR

MODEL 113B24

- Sensitivity: 5 mV/psi
(0.725 mV/kPa)
- Measurement Range (± 5 Volt Output):
1 kpsi (6895 kPa)
- Low Frequency Response: 0.005 Hz



CE



HIGH FREQUENCY ICP® PRESSURE SENSOR

MODEL 113B22

- Sensitivity: 1 mV/psi
(0.145 mV/kPa)
- Measurement Range (± 5 Volt Output):
5 kpsi (34475 kPa)
- Low Frequency Response: 0.001 Hz



HIGH FREQUENCY ICP® PRESSURE SENSOR

MODEL 113B23

- Sensitivity: 0.5 mV/psi
(0.073 mV/kPa)
- Measurement Range (± 5 Volt Output):
10 kpsi (68950 kPa)
- Low Frequency Response: 0.0005 Hz



HIGH FREQUENCY ICP® PRESSURE SENSOR

MODEL 113B03

- Sensitivity: 0.44 pC/psi
(0.064 pC/kPa)
- Measurement Range (± 5 Volt Output):
15 kpsi (103420 kPa)
- Low Frequency Response: ---



MOUNTING ADAPTOR

MODELS 061A01, 061A10, 062A01

- Model 061A01: 3/8-24
- Model 061A10: M10
- Model 062A01: 1/8-NPT



MOUNTING ADAPTOR

MODEL 061A59

- 3/8-24 Delrin, ground isolated,
up to 500 psi

SERIES 102B - GROUND ISOLATED VERSION OF THE SERIES 113B

These sensors have all of the same features and benefits of the Series 113B, plus the added benefit of having their output electrically isolated from ground, which helps prevent ground loop problems. This series can accommodate an optional ablative coating (Prefix: CA) to protect the diaphragm from thermal shock in flash-temperature applications.

HIGHLIGHTS:

- Ultra-high frequency > 500 kHz
- Fast rise time < 1 µsec
- Peak pressure and total impulse

APPLICATIONS:

- Shock Tubes and Closed Bombs
- Time-of-arrival Measurements
- Explosion, Blast, and Shock Wave



GROUND ISOLATED, DYNAMIC PRESSURE SENSOR

MODEL 102B18

- Sensitivity: 100 mV/psi (14.5 mV/kPa)
- Measurement Range (±5 Volt Output): 50 psi (345 kPa)
- Low Frequency Response: 0.5 Hz



GROUND ISOLATED, DYNAMIC PRESSURE SENSOR

MODEL 102B16

- Sensitivity: 50 mV/psi (7.25 mV/kPa)
- Measurement Range (±5 Volt Output): 100 psi (690 kPa)
- Low Frequency Response: 0.5 Hz



GROUND ISOLATED, DYNAMIC PRESSURE SENSOR

MODEL 102B15

- Sensitivity: 25 mV/psi (3.6 mV/kPa)
- Measurement Range (±5 Volt Output): 200 psi (1380 kPa)
- Low Frequency Response: 0.5 Hz



GROUND ISOLATED, DYNAMIC PRESSURE SENSOR

MODEL 102B06

- Sensitivity: 10 mV/psi (1.45 mV/kPa)
- Measurement Range (±5 Volt Output): 500 psi (3450 kPa)
- Low Frequency Response: 0.01 Hz



GROUND ISOLATED, DYNAMIC PRESSURE SENSOR

MODEL 102B04

- Sensitivity: 5 mV/psi (0.725 mV/kPa)
- Measurement Range (±5 Volt Output): 1 kpsi (6895 kPa)
- Low Frequency Response: 0.005 Hz



GROUND ISOLATED, DYNAMIC PRESSURE SENSOR

MODEL 102B

- Sensitivity: 1 mV/psi (0.145 mV/kPa)
- Measurement Range (±5 Volt Output): 5 kpsi (34475 kPa)
- Low Frequency Response: 0.001 Hz



GROUND ISOLATED, DYNAMIC PRESSURE SENSOR

MODEL 102B03

- Sensitivity: 0.5 mV/psi (0.073 mV/kPa)
- Measurement Range (±5 Volt Output): 10 kpsi (68950 kPa)
- Low Frequency Response: 0.0005 Hz

SERIES 106B - ICP® HIGH INTENSITY, ACOUSTIC PRESSURE SENSORS

Model 106B and 106B50 are high sensitivity, acceleration-compensated, ICP® quartz pressure sensors suitable for measuring intense acoustic phenomena. In fact, the series is widely used for measuring acoustic fields in operating launch vehicles and their associated payloads. The Series 106 family range spans from acoustic pressures of less than 80 dB to several psi. Similar piezoelectric technology is employed in PCB's complete range of hermetically sealed dynamic pressure sensors. These products measure pressure fluctuations from acoustic levels to tens of thousands of psi and frequencies from nearly DC to tens of kHz. Their ability to measure only pressure fluctuations above a specified frequency imposed on large static pressure fields makes them uniquely suited for such applications as combustion instability monitoring.



CE



HIGH SENSITIVITY, ICP® ACOUSTIC PRESSURE SENSOR

MODEL 106B52

- Sensitivity: 5000 mV/psi (725 mV/kPa)
- Measurement Range: 1 psi (6.89 kPa)
- Low Frequency Response (-5%): 2.5 Hz

CE



HIGH SENSITIVITY, ICP® ACOUSTIC PRESSURE SENSOR

MODEL 106B50

- Sensitivity: 500 mV/psi (72.5 mV/kPa)
- Measurement Range: 5 psi 34.45 kPa
- Low Frequency Response (-5%): 0.5 Hz

CE



HIGH SENSITIVITY, ICP® ACOUSTIC PRESSURE SENSOR

MODEL 106B

- Sensitivity: 300 mV/psi (43.5 mV/psi)
- Measurement Range: 8.3 psi (57.2 kPa)
- Low Frequency Response (-5%): 0.5 Hz

SERIES 132 - TIME OF ARRIVAL, ICP® MICRO-PRESSURE SENSORS

High-Sensitivity Micro-Pressure Sensors are well suited for short wavelength acoustic and shock wave measurements associated with high-frequency projectile detection systems. Incorporating a 1 mm diameter sensing element and integral microelectronics in a 3 mm housing, these sensors have very high sensitivity and microsecond response capable of identifying the bow and stern wave from a passing projectile. An internal 8 kHz high-pass filter eliminates low-frequency inputs. Series 132 Microsensors are available in five different physical configurations to accommodate a wide range of application requirements.

Series 132A30 Microsensors all have a sensitivity of 100 mV/psi and come in a variety of external configurations to suit your specific application.

HIGHLIGHTS:

- Shock wave time-of-arrival ICP® microsensors
- 50 psi (344 kPa) range
- Rise time <3 µsec
- Resonant frequency >1M Hz
- 0.124" (3.15 mm) diameter diaphragm



TIME OF ARRIVAL, ICP® MICRO-PRESSURE SENSORS

MODEL 132B38

- Sensitivity: 140 mV/psi (20.3 mV/kPa)
- Measurement Range: 50 psi (345 kPa)
- Low Frequency Response (-5%): 11 kHz

SERIES 134 - TOURMALINE PRESSURE BAR

This unique non-resonant sensor is designed for instantaneous, reflected (face-on) shock wave pressure measurements. A shock wave pressure impacting the very thin tourmaline crystal which operates into a silver alloyed "pressure bar", eliminates sensor structure response. The sensor has a 0.2-microsecond rise time. Since the sensor diaphragm end is coated with a conductive silver epoxy, the sensor should not be used in water or chemical environments. Series 134 can be used for shock tube calibration in a dry gas environment.

HIGHLIGHTS:

- Designed for reflected shock wave pressure measurement
- Unique non-resonating design, Tourmaline sensing element
- Pressure ranges from 1000 to 20k psi (6894 to 137,900 kPa)
- Rise time ≤ 0.2 µsec



TOURMALINE PRESSURE BAR

SERIES 134

- Sensitivity: 5 mv/psi to 0.25 mV/psi (0.73 mV/kPa to 0.04 mV/kPa)
- Measurement Range: 1000 psi to 20 kpsi (6895 kPa to 137900 kPa)
- Low Frequency Response (-5%): 0.25 kHz

SERIES 137 - ICP® FREE-FIELD BLAST PRESSURE “PENCIL” PROBE

Series 137 incorporates acceleration-compensated quartz elements and integral microelectronics for long cabledriving, improved stability and low thermal sensitivity.



MODEL 137B2XB (BNC CONNECTOR)



MODEL 137B2XA (10-32 CONNECTOR WITH PROTECTIVE COVER)



MODEL 137B25 (4-PIN CONNECTOR WITH 2-CHANNEL OUTPUT)

HIGHLIGHTS:

- Designed for reflected shock wave pressure measurement
- Unique non-resonating design, Tourmaline sensing element
- Pressure ranges from 1000 to 20k psi (6894 to 137,900 kPa)
- Rise time $\leq 0.2 \mu\text{sec}$

FREE-FIELD ICP® BLAST PRESSURE PROBE

Model Number	137B21B	137B22B	137B23B	137B24B
Measurement Range	1 kpsi [3] 6895 kPa [3]	500 psi 3447 kPa	50 psi 345 kPa	250 psi 1724 kPa
Useful Overrange	—	1 kpsi [1] 6895 kPa [1]	100 psi [1] 690 kPa [1]	500 psi [1] 3447 kPa [1]
Sensitivity	1 mV/psi 0.145 mV/kPa	10 mV/psi 1.45 mV/kPa	100 mV/psi 14.5 mV/kPa	20 mV/psi 2.9 mV/kPa
Maximum Pressure	5 kpsi 34475 kPa	5 kpsi 34474 kPa	1 kpsi 6895 kPa	5 kpsi 34474 kPa
Resolution	8.5 mpsi 0.059 kPa	1 mpsi 0.007 kPa	10 mpsi 0.069 kPa	0.7 mpsi 0.005 kPa
Resonant Frequency	> 400 kHz	> 400 kHz	> 400 kHz	> 400 kHz
Rise Time (Incident)	< 4 μsec	< 4 μsec	< 4 μsec	< 4 μsec
Non-linearity	< 1 % [2]	< 1 % [2]	< 1 % [2]	< 1 % [2]
Temperature Range	-100 to +275 °F -73 to +135 °C	-100 to +275 °F -73 to +135 °C	-100 to +275 °F -73 to +135 °C	-100 to +275 °F -73 to +135 °C
Discharge Time Constant(at room temp)	> 0.2 sec	> 0.2 sec	> 0.2 sec	> 0.2 sec
Electrical Connector	BNC Coaxial Jack	BNC Coaxial Jack	BNC Coaxial Jack	BNC Coaxial Jack
Housing Material	Aluminum	Aluminum	Aluminum	Aluminum
Diaphragm Material	Invar	Invar	Invar	Invar
Sealing	Epoxy	Epoxy	Epoxy	Epoxy
Additional Accessories				
Mating Cable Connectors	—	—	AC	—
Recommended Stock Cables (29 pF/ft, 95 pF/m)	—	—	002 Multi-strand for Blast	—
Dual Output Cable	010AYXXXQM	X	X	010AYXXXQM
Additional Versions				
10-32 Coaxial Jack Connector with Protective Cover	137B21A	137B22A	137B23A	137B24A
Placebo, BNC Jack Only	137BPB0	137BPB0	137BPB0	137BPB0
Two-Sensor Pencil Probe	137B28	137B27	137B25	137B26
Active Sensor in front, Placebo in rear	—	—	—	137B32

Notes

[1] For +10 volt output, minimum 24 VDC supply voltage required. Negative 10 volt output may be limited by output bias. [2] Zero-based, least-squares, straight line method. [3] For +/- 1V output.

SERIES 138 - ICP® TOURMALINE UNDERWATER BLAST SENSOR

Series 138 Sensors measure shock wave pressures associated with underwater explosion testing. The sensors are structured with a volumetrically sensitive tourmaline crystal, suspended and sealed in an insulating, oil-filled vinyl tube. They have integral microelectronics. These underwater shock wave sensors provide a clean, non-resonant, high-voltage output through long cables in adverse underwater environments. They can be supplied with a sealed cable of appropriate length, ready to operate. Two physical configurations are available.

HIGHLIGHTS:

- ICP® underwater blast explosion pressure probes
- Ranges from 1000 to 50k psi (6894 to 344740 kPa)
- Rise time <1.5 µsec
- Resonant frequency >1M Hz

CE

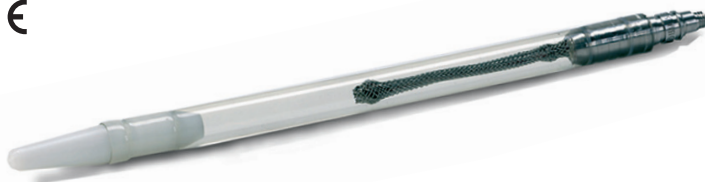

UNDERWATER TOURMALINE BLAST SENSORS FOR PEAK, OVERPRESSURE AND HIGH-PRESSURE BUBBLE ENERGY MEASUREMENTS

SERIES 138A MODEL NUMBERING SYSTEM

1) Connector Type

Default	10-32 Coaxial Jack		
W	Attached Waterproof Cable		
	2A) ICP® Output Pressure Range and Tube Length / Configuration		
	138A01	Measurement Range: 1000 psi (6895 kPa) with 7.6 in.(193 mm) Length and Sinker Hole for Vertical Mounting	
	138A02	Measurement Range: 1000 psi (6895 kPa) with 4.7 in. (120 mm) Length for Horizontal Mounting	
	138A05	Measurement Range: 5000 psi (34475 kPa) with 7.6 in.(193 mm) Length and Sinker Hole for Vertical Mounting	
	138A06	Measurement Range: 5000 psi (34475 kPa) with 4.7 in. (120 mm) Length for Horizontal Mounting	
	138A10	Measurement Range: 10 kpsi (68950 kPa) with 7.6 in.(193 mm) Length and Sinker Hole for Vertical Mounting	
	138A11	Measurement Range: 10 kpsi (68950 kPa) with 4.7 in. (120 mm) Length for Horizontal Mounting	
	138A25	Measurement Range: 25 kpsi (172375 kPa) with 7.6 in.(193 mm) Length and Sinker Hole for Vertical Mounting	
	138A26	Measurement Range: 25 kpsi (172375 kPa) with 4.7 in. (120 mm) Length for Horizontal Mounting	
	138A50	Measurement Range: 50 kpsi (344750 kPa) with 7.6 in. (193 mm) Length and Sinker Hole for Vertical Mounting	
	138A51	Measurement Range: 50 kpsi (344750 kPa) with 4.7 in. (120 mm) Length for Horizontal Mounting	
		2B) Charge Output Pressure Range and Tube Length / Configuration	
		138A	Measurement Range: 25 kpsi (172375 kPa) with 7.6 in.(193 mm) Length and Sinker Hole for Vertical Mounting
		138A24	Measurement Range: 25 kpsi (172375 kPa) with 4.7 in. (120 mm) Length for Horizontal Mounting
	3) Attached Model 038 Cable Length (add only if ordering the W option)		
	/038CYxxxAC	Specify total length xxx in feet. Cable is terminated with BNC plug connector	
	/M038CYxxxAC	Specify total length xxx in meters. Cable is terminated with BNC plug connector	

Example

W	138A05	/038CY300AC	Attached 300 ft. 038 cable, 5000 psi measurement range, 7.6 in. length, sinker hole, BNC plug termination
---	--------	-------------	---



PRESSURE PRODUCTS FOR BALLISTIC TESTING

BALLISTIC PRESSURE SENSORS

PCB® has supplied high frequency, durable, Quartz ballistics pressure sensors in both charge and ICP® voltage mode versions for over forty years. The Series 109 ICP® ballistic pressure sensors are acceleration compensated, and have a ceramic coated integral diaphragm to attenuate thermal shock associated with burning propellants. This series also features a floating clamp nut that reduces strain sensitivity on the sensor body due to mounting torque. The ICP® integral electronics are protected from shock such as that found in gun test applications. Series 119 charge output versions are also available.

In the early 1970's PCB® worked with members of the Sporting Arms and Ammunition Manufacturers' Institute (SAAMI) to develop an accurate, durable, standard test method for sporting arms ammunition. Pressure sensors suitable for implementation into a standardized test method for rapid-fire production testing of ammunition were required. This method involved a sensor with a machined curved diaphragm that measures pressure directly through the shell case. Based on this success, the conformal sensor became a SAAMI/ANSI "National Standard" for ammunition testing.

Series 117B conformal pressure sensors measure true gun chamber pressure directly through an unmodified shell case. Since the sensor diaphragm is machined to conform flush to the specific chamber diameter, the measurement process is

APPLICATIONS:

- Ammunition and Gun Testing
- Explosives Testing
- Closed Bombs
- Recoil Mechanisms
- Ultra High-frequency Detonation

not altered or changed in any way. There are no cartridges to be drilled or troublesome gas passages to be cleaned when using the conformal method. Conformal sensors have proven to be rugged, stable instruments, lasting thousands of rounds. Since the same sensor may outlast the life of many barrels, it is possible to start and finish ammunition batch qualification testing without experiencing sensor failure during the test.

Keeping with our tradition, PCB® continues to offer a complete line of sensors for conformal and case mouth ballistic measurements. All PCB® sensors are provided with NIST traceable calibration. For pre-calibration stabilization purposes, all ballistic pressure sensors are hydraulically cycled at high pressures and most are test fired in the PCB® ballistic firing range. PCB® also offers a high pressure static calibration system, Model 905C, for on-site use in ballistic labs. Side-by-side dynamic/static comparison calibration services are offered for PCB® and competitors' ballistic sensors.

SERIES 109 ICP® BALLISTIC SENSORS

PCB® offers a complete line of high pressure ballistic sensors with integral electronics. They operate from a PCB® constant-current signal conditioner and provide a high-voltage, low-impedance output. ICP® sensors are well suited for applications involving long cables and operation in dirty factory or field environments.

These sensors incorporate a captivated floating clamp nut and a more stable structure for improved accuracy, reliability, and lower thermal transient sensitivity. They are structured with quartz sensing elements, built-in microelectronics, and an integral machined ceramic-coated diaphragm for greater durability, overrange capability, high-frequency response, and improved linearity.

Models 109C11 and 109C12 are acceleration-compensated ICP® sensors for high-energy, high-frequency applications, such as detonation, closed bomb combustion, and explosive blast measurements under extreme shock conditions.



HIGH PRESSURE ICP® BALLISTIC PRESSURE SENSOR

MODEL 109C11

- Sensitivity: 0.07 mV/psi (0.010 mV/kPa)
- Measurement Range: 80000 psi (552000 kPa)
- Maximum Pressure: 125000 psi (862000 kPa)



HIGH PRESSURE ICP® BALLISTIC PRESSURE SENSOR

MODEL 109C12

- Sensitivity: 0.07 mV/psi (0.010 mV/kPa)
- Measurement Range: (for ± 7V output) 100000 psi (690000 kPa)
- Maximum Pressure: 125000 psi (862000 kPa)

SERIES 119 CHARGE MADE BALLISTIC SENSORS

Charge Mode Pressure Sensors are well suited for high-pressure ballistics, detonation, and explosive research and test applications.

These sensors incorporate stable quartz-sensing elements, a durable-machined ceramic-coated integral diaphragm and floating clamp nut.

Models 119B11 and 119B12 are unique, acceleration-compensated, high resolution ballistic sensors designed for high-pressure, high-energy ballistics, detonation, and explosive applications under high-shock conditions, such as those that might be encountered in howitzer and liquid-propellant weapons. Two dynamic ranges of 80,000 and 100,000 psi are available.



HIGH PRESSURE BALLISTIC PRESSURE SENSOR

MODEL 119B11

- Sensitivity (±15%): 0.25 pC/psi (0.036 pC/kPa)
- Measurement Range: 0 to 80000 psi (0 to 552000 kPa)
- Maximum Pressure: 100 kpsi (690000 kPa)



HIGH PRESSURE BALLISTIC PRESSURE SENSOR

MODEL 119B12

- Sensitivity (±15%): 0.25 pC/psi (0 to 827000 kPa)
- Measurement Range: 0 to 120000 psi (552000 kPa)
- Maximum Pressure: 125 kpsi (862000 kPa)

SERIES 117B - CHARGE MODE CONFORMAL BALLISTIC SENSORS

Conformal ballistic sensors measure true gun chamber pressure directly through the cartridge case. The diaphragm of the conformal sensor is contoured to match a specific chamber diameter. An alignment guide and spacers help the user to install the sensor flush with the gun chamber walls.

The conformal ballistic sensor, when correctly installed, has a proven life expectancy of hundreds of thousands of rounds, outlasting many test barrels. Rapid-fire testing is possible since there are no cartridges to drill and align, no diaphragm abrasives to apply, and no gas passages to clean. The conformal sensor does not affect operation of the test barrel, nor change the measurement process.

Developed in cooperation with members of SAAMI to provide an accurate rapid-fire electronic production test method to replace the mechanical “copper crusher,” the conformal sensor has experienced 20 years of proven performance.

Conformal calibration through an unfired, unmodified empty cartridge shell case with PCB® Series 090B Calibration Adaptor accounts for the effects of the cartridge case. Output from the conformal sensor is compatible with any charge amplifier. The PCB® Model 443A53 Digital Peak Holding System with a charge amplifier and auto-reset peak meter facilitates rapid-fire testing of production ammunition.

The two machined flats near the connector end, an alignment guide, and a captive retaining nut facilitate installation. The nut automatically extracts the sensor when it is unscrewed. Series 090B Calibration Adaptor permits static calibration of the Model 117B Sensor, with pressures to be applied to the empty cartridge case. Spacer set is supplied to facilitate flush installation of the sensor.

HIGHLIGHTS:

- Proven long life
- Outlasts life of many barrels
- ANSI/SAAMI standards Z299 test method
- Allows rapid-fire testing
- No drilled cases or recessed passages
- Cost effective

Conformal vs. Standard Case Mouth Installation

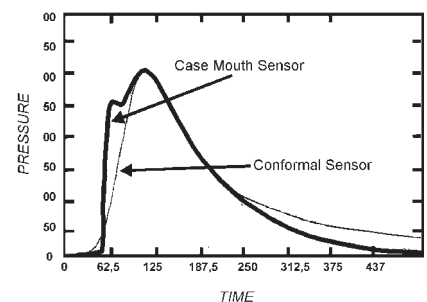

MODEL 117B

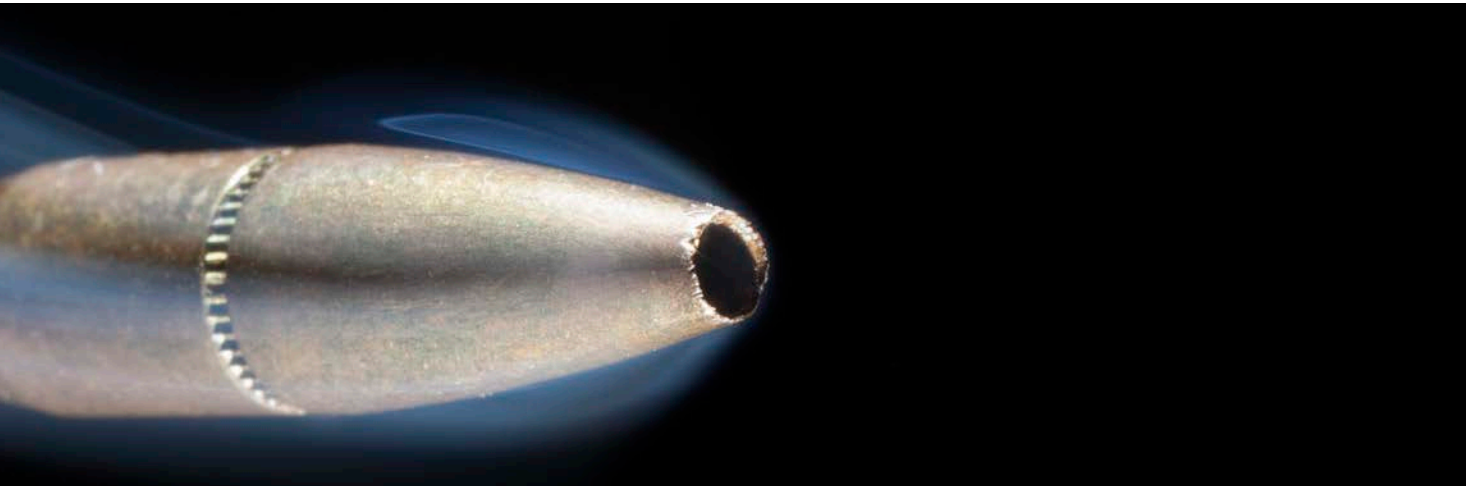

Typical Conformal Sensor Installation in Universal Receiver

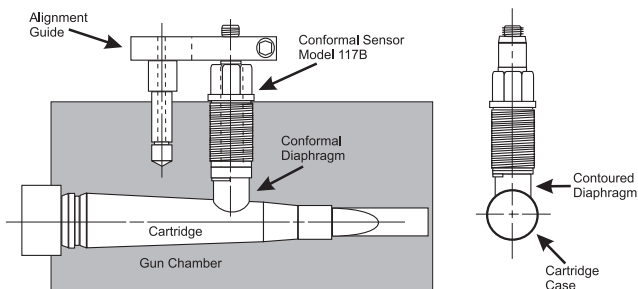

Typical Conformal Calibration Adaptor System

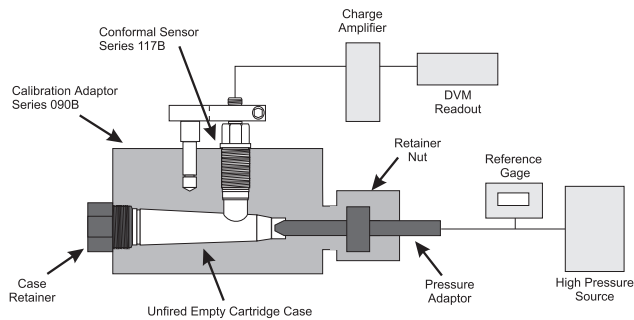

BALLISTIC PRESSURE SENSORS SMALL ARMS TESTING

Conformal Gages		
Contact factory for proper model number to match the caliber of ammunition under test		
Model Number	117B Small Caliber	117B Large Caliber
Measurement Range	35 kpsi 241 kPa	60 kpsi 414 kPa
Sensitivity	0.110 pC/psi 0.016 pC/kPa	0.140 pC/psi 0.021 pC/kPa
Maximum Pressure	40 kpsi 275 kPa	80 kpsi 552 kPa
Resolution	2 psi 14 kPa	2 psi 14 kPa
Resonant Frequency	> 300 kHz	> 300 kHz
Rise Time (Reflected)	< 2 μsec	< 2 μsec
Non-linearity	< 2 % [1]	< 2 % [1]
Acceleration Sensitivity	< 0.02 psi/g < 0.014 psi/(m/s ²)	< 0.02 psi/g < 0.014 psi/(m/s ²)
Temperature Range	-100 to +400 °F -73 to +204 °C	-100 to +400 °F -73 to +204 °C
Electrical Connector	10-32 Coaxial Jack	10-32 Coaxial Jack
Housing Material	17-4SS	17-4SS
Diaphragm Material	17-4SS	17-4SS
Additional Accessories		
Conformal Calibration Adaptors	090B	090B
Brass Calibration	Contact factory for assistance, requires customer supplied brass casings and conformal adaptor	
Mating Cable Connectors	EB	EB
Recommended Stock Cables	003	003
Notes		
[1] Zero-based, least-squares, straight line method.		

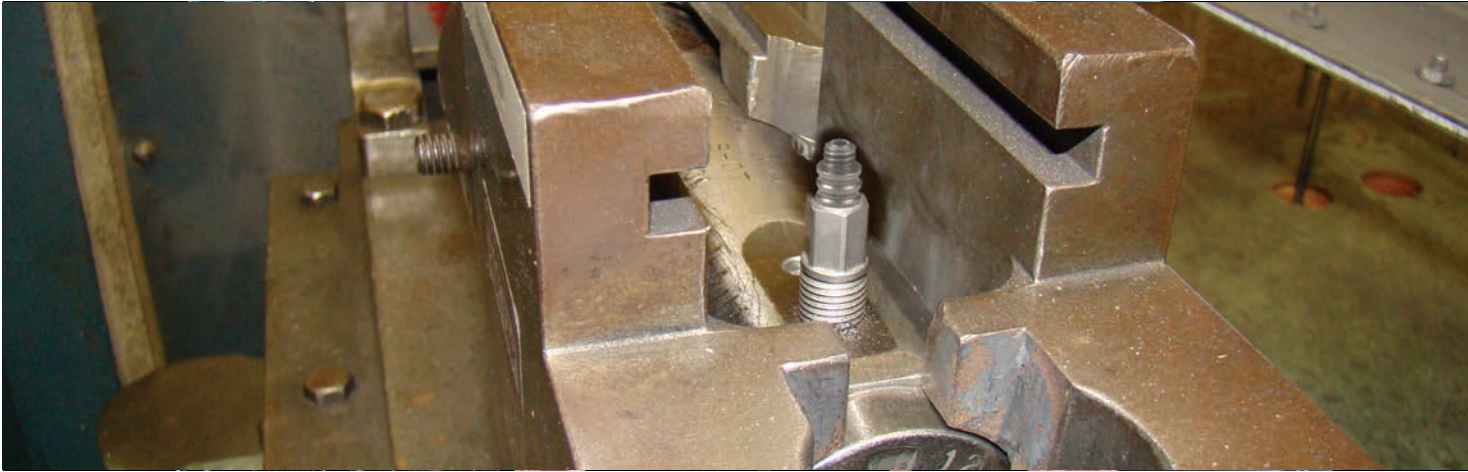

MODEL 118A07 - CHARGE MODE SHOT SHELL SENSOR

For production testing of shotshell ammunition per SAAMI recommendations, this upgraded sensor measures chamber pressure through the case wall of an unmodified cartridge. The number of rounds capability has increased due to a recently modified design.

Recommended Ballistic Peak Pressure Monitoring System

CE



MODEL 444A53
Ballistic Peak Pressure Monitoring System See Details on page 23.



BALLISTIC SHOT SHELL PRESSURE SENSOR

MODEL 118A07

- Sensitivity ($\pm 15\%$): 0.28 pC/psi (0.041 pC/kPa)
- Measurement Range: 15000 psi (103400 kPa)
- Maximum Pressure: 35000 psi (241316 kPa)



FORCE & STRAIN PRODUCTS FOR STRUCTURAL IMPACT

IMPACT FORCE SENSORS

Quartz, piezoelectric force, and strain sensors are durable measurement devices, which possess exceptional characteristics for the measurement of dynamic force and strain events.

CE



ICP® QUARTZ FORCE RING FOR PERFORMANCE APPLICATIONS

SERIES 201B

- Sensitivity: 50 to 1 mV/lb (11240 to 224.8 mV/kN)
- Measurement Range: 100 to 5000 lb (0.4448 to 22.24 kN)
- Low Frequency Response (-5%): 0.006 to 0.0003 Hz

CE



GENERAL PURPOSE QUARTZ FORCE SENSORS

SERIES 208C

- Sensitivity: 500 - 1 mV/lb (112.41 - 0.2248 mV/N)
- Measurement Range: 10 - 5000 lb (44.5 - 22.24 kN)
- Low Frequency Response (-5%): 0.0003 - 0.01 Hz

APPLICATIONS:

- Crash Testing
- Crushing
- Drop Testing
- Fatigue Testing
- Fracture Testing
- Materials Testing
- Penetration Testing
- Dynamic Tension & Compression
- Impact & Repetitive Applications
- Drop Testing
- Materials Testing



MODEL 740B02 - DYNAMIC ICP® STRAIN SENSORS

Structured with a quartz sensing element and microelectronic circuitry in a low-profile titanium housing, this sensor is ideal for high-resolution measurements of dynamic strain. This unit is compatible with PCB's ICP® Sensor signal conditioners and is capable of driving long cables. Typical applications include: active vibration control, noise-path analysis, modal testing, and use on aircraft and marine hulls, composite materials, and "smart" structures.

This product is CE-marking compliant to European Union EMC Directive, based upon conformance testing to the following European norms:

- EN 50081-1: 1992 Emissions
- EN 50082-1: 1992 Immunity

HIGHLIGHTS:

- Measures small strain on top of large static loads
- Provides high resolution and wide dynamic range
- Designed with low profile and integral cable
- Contains built-in microelectronic circuitry
- Detects wave propagation for material velocity characterization



Photo Courtesy of Siemens and Belgian Defense

TYPICAL APPLICATION:

An epoxy-bonded Model 740B02 Strain Sensor provides a control signal for an actively damped flexible robot manipulator, illustrated above. The electronic controller, with vibration feedback from the strain sensor, provides a signal to the amplifier, such that vibration amplitude is minimized. The active control system permits rapid settling time for a step rotation of the manipulator arm.

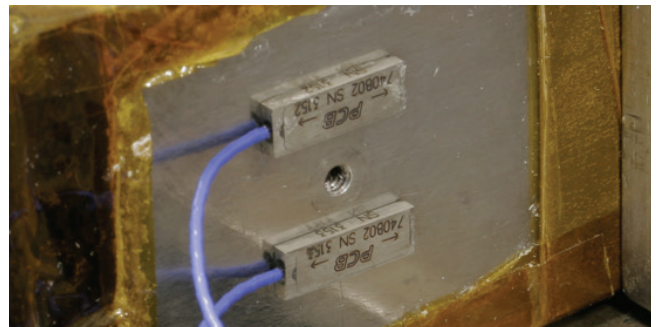

CE



ICP® PIEZOELECTRIC STRAIN SENSOR

MODEL 740B02

- Sensitivity ($\pm 20\%$): 50 mV/ μe
- Measurement Range: 0 to 120000 psi (552000 kPa)
- Maximum Pressure: 125 kpsi (862000 kPa)

CE



ICP® PIEZOELECTRIC STRAIN SENSOR

MODEL 740M04

- Sensitivity ($\pm 20\%$): 5 mV/ μe
- Measurement Range: 0 to 120000 psi (552000 kPa)
- Maximum Pressure: 125 kpsi (862000 kPa)



PLACEBO TRANSDUCERS

For any testing in which the environmental operating conditions of a transducer vary with time and/or location, several requirements must be fulfilled before measurement uncertainty analysis is justified. Included among the requirements are good measurement system design practices, such as adequate low- and high-frequency response and data-sampling rates, appropriate anti-aliasing filter selection, proper grounding and shielding, and much more.

In addition to these requirements, data validation must be performed to establish that each transducer responds only to the environmental stimulus for which it is intended. For piezoelectric and piezoresistive transducers, “placebo” (IEST-RP-DTE011.1) transducers enable data validation to be accomplished. The referenced IEST standard defines a placebo transducer as ‘identical to a “live” unit in every parameter except for mechanical sensitivities.’ The placebo transducer should respond only to extraneous “environmental factors.” Ideally, its output would be zero. Any signal output from it would indicate that signals from the “live” transducers could be corrupted.

Every transducer responds to its environment in every way it can. For example, accelerometer specifications include their response to thermal, acoustic, strain, and radiation stimuli, to name a few. While accelerometers must have their response to acoustic pressure specified, pressure transducers must have their response to acceleration specified. Thus, one transducer’s desired response becomes another’s undesired response.

These undesired responses can cause a change in transducer sensitivity or can result in additive, spurious signals at the transducer’s output attributable to thermoelectric, electromagnetic, triboelectric and other self-generating noise phenomena. Since the test or instrumentation engineer has the best understanding of the test environment, he/she becomes responsible for data validation. The transducer manufacturer can assist by supplying “placebo” transducers to support this validation process.



Model 102BPBO



137BPBO



Model 113B22PBO



Model 356A32PBO



Model 350B21PBO



Model 354C03PBO



Model 356A33PBO



Model 3991A11PBO

Other models available upon special request. Contact your local Sales Representative for more information.

CALIBRATION PRODUCTS

PRESSURE CALIBRATION SYSTEMS

In addition to the products listed below, PCB® is also able to perform a number of special calibration and testing services, upon request. These include acceleration sensitivity, ballistics firing range, cold gas shock tube, discharge time constant, temperature effects from -320 to $+1000$ °F (-196 to $+535$ °C), hydrostatic and hermeticity, mechanical shock, and PIND (Particle Impact Noise Detection).



LOW PRESSURE CALIBRATION SYSTEM

MODEL K9903C

- Maximum pressure: 1 MPa (150 psi)
- Pneumatic calibration media
- 'Step' pressure input
- 5 ms rise time
- Automated pressure controller



MEDIUM PRESSURE CALIBRATION SYSTEM

MODEL K9907C

- Maximum pressure: 6.9 MPa (1000 psi)
- Compressed air or industrial helium media
- 'Step' pressure input
- Fastest rise times using poppet valve mechanism



HIGH PRESSURE CALIBRATION SYSTEM

MODEL K9913C

- Maximum pressure: 103 MPa (15000 psi)
- Silicon oil media
- 'Impulse' pressure input
- 3 ms rise time with 7 ms pulse duration using drop mass

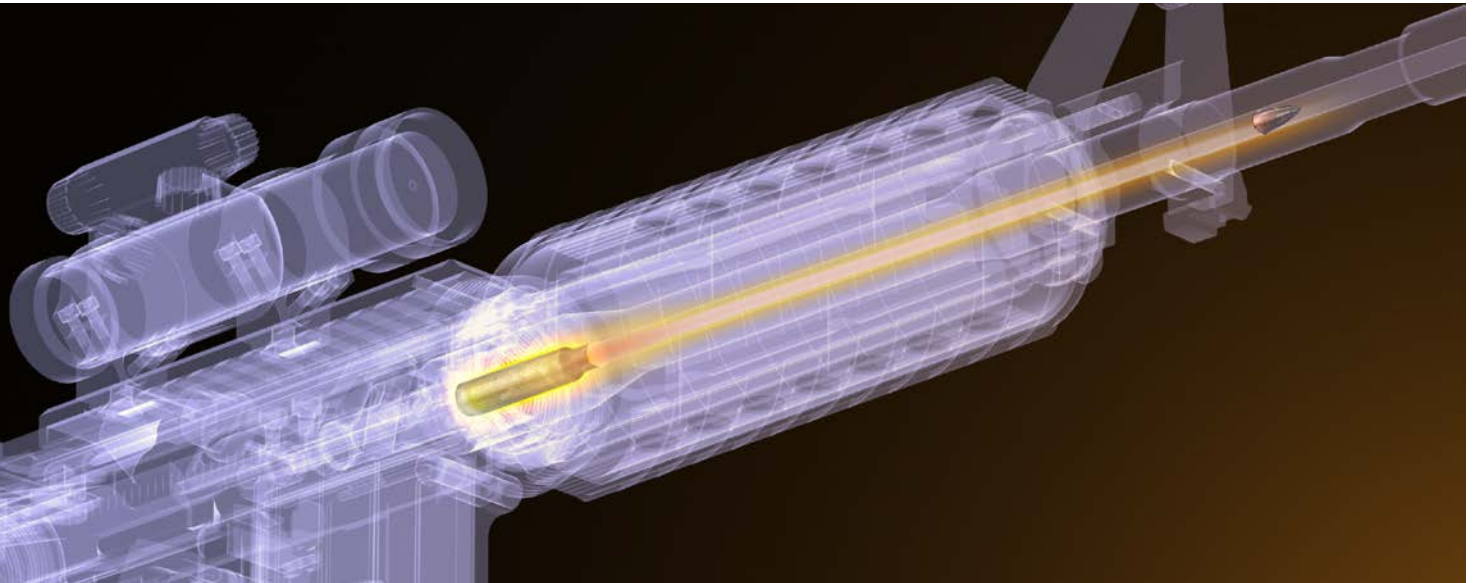

ULTRA HIGH PRESSURE CALIBRATION SYSTEM

MODEL K9905D

- Maximum pressure: 550 MPa (80000 psi)
- Hydraulic calibration media
- 'Step' pressure input
- Quasi-static method available for ballistics sensors and brass calibration
- SAAMI standard brass calibration



INSTRUMENTED SHOCK TUBE

MODEL K9901C

- Enables high frequency resonant frequency measurement
- High speed time of arrival measurements
- Operates with compressed air or inert gas
- Max burst pressure 9.6 MPa (1400 psi)



MODEL 9155D - ACCELEROMETER CALIBRATION WORKSTATION

The Accelerometer Calibration Workstation Model 9155D is a turnkey solution that provides all the necessary components out of the box. Principal components include a Windows® PC Controller, software, printer and 24-bit data acquisition card. System options allow custom configuration of the modular system with a variety of shakers and shock towers, accelerometer signal conditioning, test software modules and mounting accessories.

The system often includes the 9155D-830 or 9155D-831 air bearing shaker. With our air bearing shakers, customers benefit from two things: PCB's R&D investment in precision metrology and years of experience on PCB's accelerometer production line. The real world experience these shakers have in our factory results in a mature design that has been 'hardened' for durability and optimized for usability.



HIGHLIGHTS:

- Wide frequency range of 0.1 Hz to 20 kHz
- Resonant frequency testing up to 50 kHz
- Drastically reduces uncertainty by virtually eliminating transverse motion
- Integral quartz ICP® reference for long-term stability
- Lorentz force coil enables rapid centering of sensors with varying mass

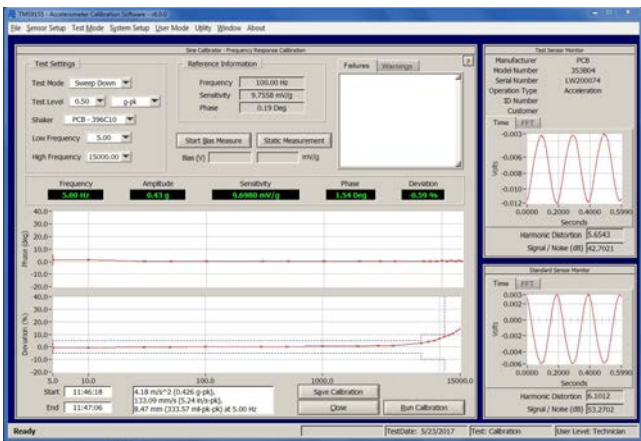

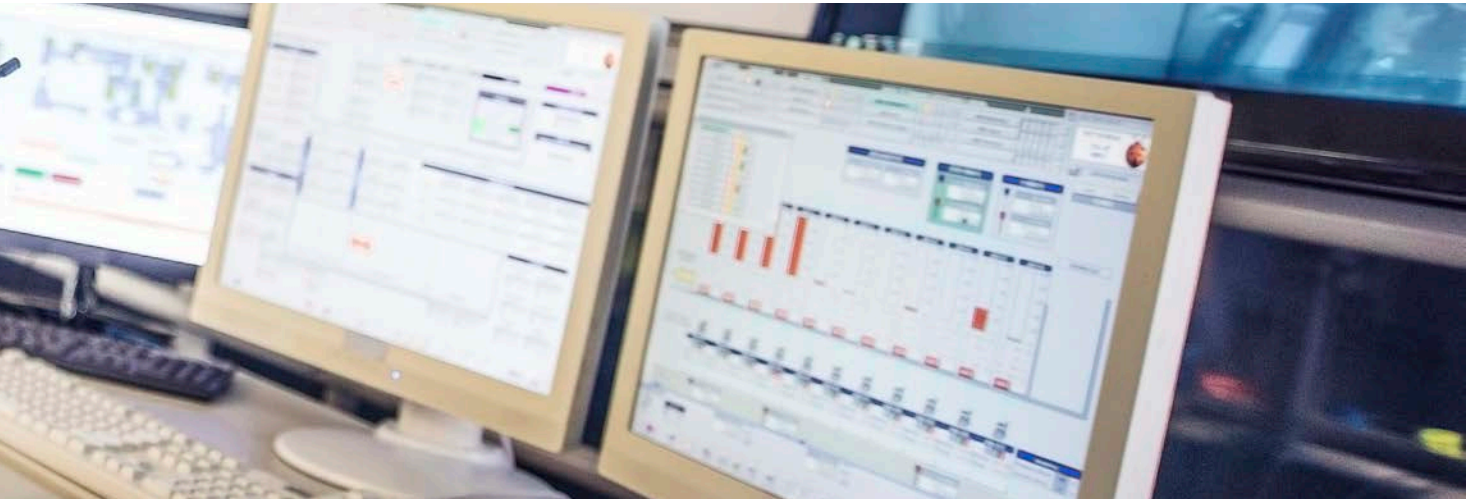

MODEL K9525C - SHOCK ACCELEROMETER CALIBRATION WORKSTATION

The PneuShock™ Model K9525C is a turnkey calibration solution for shock accelerometers. Shocks pulses are created at accelerations from 20 g to 10000 g using a pneumatically operated projectile to strike an anvil and excite the sensor. By controlling both the level and the duration of the air pressure applied, the user gains greater control and consistency of the impacts. PneuShock provides verification and linearity check. We also offer Model 9155D-525 as an optional module for the 9155D Accelerometer Calibration Workstation.

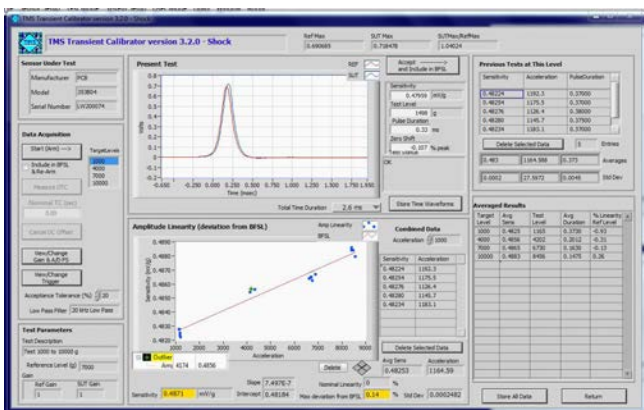

HIGHLIGHTS:

- Amplitude linearity calibration of shock and crash sensors from 20 g to 10000 g, per ISO 16062-22
- Controlled and consistent impacts using state-of-the-art pneumatically
- Easy refinement of impulse shape and frequency content using a wide variety of impact anvils
- Superior impact control through drive pressure and duration control



SPECIALIZED INSTRUMENTATION

MODEL LxT1-QPR TYPE 1 SOUND LEVEL METER FIREARMS DETECTION SYSTEMS

Model LxT1-QPR handheld sound level meter features a small, lightweight ergonomic design, available real-time 1/1 and 1/3 octave frequency analysis, and comes standard with a 100dB dynamic range and a 377C10 microphone for measuring 178 dB typical. When configured with PCB Models 377C01 or 377A12 1/4" microphones, the system can safely measure high level acoustic signatures typically associated with gun-fire.

Model LxT1-QPR can be upgraded to allow easy comparison of multiple shots, high-speed data logging and a large LCD display which is easily readable in all lighting conditions. In addition, the unit can be powered for 16 hours on 4xAA batteries for ease of use in the field. Finally, Model LxT1-QPR has 2GB of on-board memory and a USB connection to PC for data downloading and reporting.



A full line of accessories is available including software, sound level calibrators, outdoor microphone systems, weatherproof enclosures for short and long-term monitoring and a variety of tripods and mounting hardware. For complete specifications on Model LxT1-QPR, please visit Larson Davis at <http://www.larsondavis.com/Products/soundlevelmeters/modelLxT1qpr>.

DB LIMIT (1/4" MICROPHONE)

- 377C01 = 168dB
- 377A12 = 182dB



MODEL 444A53: BALLISTIC PEAK PRESSURE MONITORING SYSTEM

The Model 444A53 is a modular-style signal conditioner that combines a dual-mode amplifier module (443B102), a peak voltage monitoring module (444A152), and an AC power supply module (441A101) into one, integrated device. The unit connects directly with an ICP® or charge output pressure sensor, normalizes sensor sensitivity, and displays peak transient measurement signals in voltage or pressure units.

Unlike a digitizing peak detector, which is limited in accuracy by the sampling rate, the 444A152 peak monitoring module captures the true peak voltage of the transient event. Additionally, the module incorporates a 20 kHz low pass filter, offers reset capability between events, and delivers an analog output signal to profile the entire pressure event.

This device is ideal for barrel chamber pressure testing, lot testing of ammunition, and cartridge load studies. Two alternative versions (Models 444A51 and 444A52) eliminate the dual mode amplifier module and are intended for direct connection to ICP® pressure sensors, any direct voltage input, or for existing systems that already utilize a separate charge amplifier.

SPECIFICATIONS	
Model	444A53
Performance	
Channels	1
Input Sensor Type (selectable)	ICP®, charge, voltage
Input Sensitivity Adjustment (normalization)	0.001 to 9999 (pC or mV per unit)
Excitation Supplied (ICP® mode)	24 VDC @ 0 to 20 mA
Voltage Gain (ICP® or voltage mode)	0.1 to 1000
Charge Converter (charge mode)	0.1 to 10000 mV/pC
Charge Input Limit	100000 pC
Drift (long DTC mode)	<0.03 pC/sec
Discharge Time Constant (selectable)	0.18, 1.8, 10, 100, 1000, >100000 sec
Peak / DVM Display	4-digit LCD
Peak Voltage Display Range (infinite hold)	± 10 V
Accuracy	± 1%
Display Mode	Peak, DVM, Bias Test (for ICP® sensors)
Rise Time	<1 µsec
Low Pass Filter	20 kHz
Peak Reset	Manual, Remote, or Auto (1 to 99 sec)
Environmental	
Temperature Range	+32 to +120 °F 0 to +50 °C
Electrical	
Power Required	100 to 240 VAC, 50 to 60 Hz
Relays (2 Form C each with HI or LOW setpoint)	1 A @ 30 VDC, 1/2 A @ 125 VAC
Physical	
Size (h x w x d)	6.2 x 6.06 x 10.2 in 157.5 x 153.9 x 259.1 mm
Electrical Connectors (input, peak/DVM output, analog output, remote reset)	BNC Jack

SIGNAL CONDITIONING & CONVERTERS

PCB® SIGNAL CONDITIONING

CE



LINE POWERED, ICP® SIGNAL CONDITIONER

MODEL 483C28

- Sensor Input Type(s): ICP®, Voltage, Bridge/Differential
- Channels: 8
- Frequency Range (-5%): 0.05 to 100000 Hz

CE



LINE POWERED, ICP® SIGNAL CONDITIONER

MODEL 482C05

- Sensor Input Type(s): ICP®
- Channels: 4
- Frequency Range (-5%): 0.1 to >1000 kHz

CE



LINE POWERED, ICP® SIGNAL CONDITIONER

SERIES 483C

- Sensor Input Type(s): ICP®
- Channels: 8
- Frequency Range (-5%): 0.1 to >1000 kHz

CE



LINE POWERED, ICP® SIGNAL CONDITIONER

MODEL 482C64

- Sensor Input Type(s): ICP®, Voltage, Charge
- Channels: 4
- Frequency Range (-5%): 0.05 to 75000 Hz

CE



LINE POWERED, ICP® SIGNAL CONDITIONER

MODEL 482C27

- Sensor Input Type(s): ICP®, Voltage, Bridge/Differential
- Channels: 4
- Frequency Range (-5%): 0.05 to 100000 Hz

CE



LINE POWERED, ICP® SIGNAL CONDITIONER

MODEL 482C16

- Sensor Input Type(s): ICP®, Voltage
- Channels: 4
- Frequency Range (-5%): 0.05 to 100000 Hz



CE



**BATTERY-POWERED, ICP®
SENSOR SIGNAL CONDITIONER**
MODEL 482A21

- Sensor Input Type(s): ICP®, Voltage
- Channels: 3
- Voltage Gain (±1%): 1:1

CE



**BATTERY-POWERED, ICP®
SENSOR SIGNAL CONDITIONER**
MODEL 482B11

- Sensor Input Type(s): ICP®, Voltage
- Channels: 1
- Voltage Gain (±1%): x1 x10 x100

CE



**BATTERY-POWERED, ICP®
SENSOR SIGNAL CONDITIONER**
MODEL 480C02

- Sensor Input Type(s): ICP®, Voltage
- Channels: 4
- Frequency Range (-5%):
0.05 to 100000 Hz

CE



**BATTERY-POWERED, ICP®
SENSOR SIGNAL CONDITIONER**
MODEL 480E09

- Sensor Input Type(s): ICP®, Voltage
- Channels: 4
- Frequency Range (-5%):
0.05 to 100000 Hz

CE



**BATTERY-POWERED, ICP®
SENSOR SIGNAL CONDITIONER**
MODEL 480B21

- Sensor Input Type(s): ICP®, Voltage
- Channels: 3
- Frequency Range (-5%):
0.05 to 100000 Hz

SERIES 402 IMPEDANCE CONVERTERS AND IN-LINE VOLTAGE FOLLOWER AMPLIFIER

Series 402A In-line voltage follower amplifiers, similar to the Series 422E charge converters, serve to convert charge output sensor signals to low-impedance voltage signals. They are recommended for applications requiring high frequency response up to 1 MHz, and for applications where sensor output (pC/unit) exceeds the maximum input range (pC) allowed in the Series 422E.

The voltage sensitivity, V , of a system including a charge output sensor, low-noise cable and voltage follower amplifier can be determined mathematically by the equation $V=Q/C$ where Q is the charge sensitivity of the sensor in Coulombs and C is the total system capacitance in Farads. The total system capacitance is the result of the sum of the capacitance of the sensor, the capacitance of the interconnect cable, and the input capacitance of the voltage amplifier. Choose a voltage follower amplifier with an input capacitance that provides the sensitivity desired, while keeping the total output voltage (range \times sensitivity) within the ± 10 volt limit. Voltage follower amplifiers do not invert the polarity of the measurement signal.



IN-LINE VOLTAGE FOLLOWER AMPLIFIERS

MODEL 402A

- Input Capacitance: < 8.0 pF
- Discharge Time Constant: 1.0 second
- Frequency Response ($\pm 5\%$): 0.5 to 1M Hz



IN-LINE VOLTAGE FOLLOWER AMPLIFIERS

MODEL 402A02

- Input Capacitance: $100 \pm 10\%$ pF
- Discharge Time Constant: 10 second
- Frequency Response ($\pm 5\%$): 0.05 to 1M Hz



IN-LINE VOLTAGE FOLLOWER AMPLIFIERS

MODEL 402A03

- Input Capacitance: $1000 \pm 10\%$ pF
- Discharge Time Constant: 100 second
- Frequency Response ($\pm 5\%$): 0.005 to 1M Hz

SERIES 422 IN LINE ICP POWERED CHARGE CONVERTERS



IN-LINE CHARGE CONVERTER

MODEL 422E52

- Sensitivity (Charge Conversion) ($\pm 2.5\%$): 10 mV/pC
- Output Voltage: ± 5.0 V
- Temperature Range (Operating): -65 to +250 °F (-54 to +121 °C)



IN-LINE CHARGE CONVERTER

MODEL 422E36

- Sensitivity ($\pm 2\%$): 10 mV/pC
- Output Voltage: ± 2.5 V
- Temperature Range: -65 to +250 °F (-54 to +121 °C)



IN-LINE CHARGE CONVERTER

MODEL 422E51

- Sensitivity ($\pm 5.0\%$): 100 mV/pC
- Output Voltage: ± 5.0 V
- Temperature Range: -65 to +250 °F (-54 to +121 °C)



IN-LINE CHARGE CONVERTER

MODEL 422E35

- Sensitivity ($\pm 2\%$): 1 mV/pC
- Output Voltage: ± 2.5 V
- Temperature Range: -65 to +250 °F (-54 to +121 °C)



 **PCB PIEZOTRONICS**
AN AMPHENOL COMPANY

3425 Walden Avenue, Depew, NY 14043 USA

pcb.com | info@pcb.com

© 2021 PCB Piezotronics - all rights reserved. PCB Piezotronics is a wholly-owned subsidiary of Amphenol Corporation. Endevco is an assumed name of PCB Piezotronics of North Carolina, Inc., which is a wholly-owned subsidiary of PCB Piezotronics, Inc. Accometrics, Inc. and The Modal Shop, Inc. are wholly-owned subsidiaries of PCB Piezotronics, Inc. IMI Sensors and Larson Davis are Divisions of PCB Piezotronics, Inc. Except for any third party marks for which attribution is provided herein, the company names and product names used in this document may be the registered trademarks or unregistered trademarks of PCB Piezotronics, Inc., PCB Piezotronics of North Carolina, Inc. (d/b/a Endevco), The Modal Shop, Inc. or Accometrics, Inc. Detailed trademark ownership information is available at www.pcb.com/trademarkownership.

AD-Explosive-Gun-Impact-0921

Aufgrund laufender Weiterentwicklungen sind Änderungen der Spezifikationen vorbehalten. Alle Angaben vorbehaltlich Satz- und Druckfehler.

EC TEST Systems Sp. z o.o.

ul. Ciepłownicza 28, 31-574 Kraków

Tel. +48 12 627 77 77 | Fax +48 12 627 77 70

drgania • akustyka • termowizja • szybkie kamery

biuro@ects.pl | www.ects.pl